

Uno Thin Client



Application: Thin Client / Network

System Information:

| | |
|------------|-----------------------------|
| Main Board | 3V700A-1R50E |
| Max Memory | DDR II 1GB |
| CPU | VIA Eden(V4) 500MHz |
| LAN | 1xRealtek RLT8100C 10T/100T |
| USB | Two external ports |
| SATA | one SATA channel |
| Power | DC 12V in |

Chassis Information:

| | |
|---------------|------------------------------|
| Dimension | 180 x 125 x 40.2 mm |
| Material | PMMA |
| Color | Black |
| Weight | 1Kg |
| Storage Space | 2.5"HDD / Compact Flash card |

Order Information:

| | |
|--------------|---------------------|
| 3V700A-1R50E | VIA Eden 500MHz |
| 3V700A-1R10U | VIA Eden ULV 1.0GHz |

Dimension:

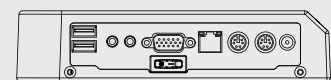
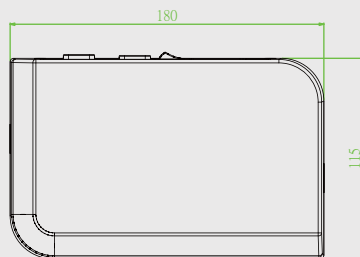

3V700A

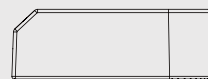
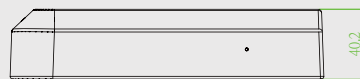
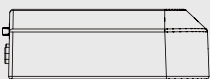

3V700C

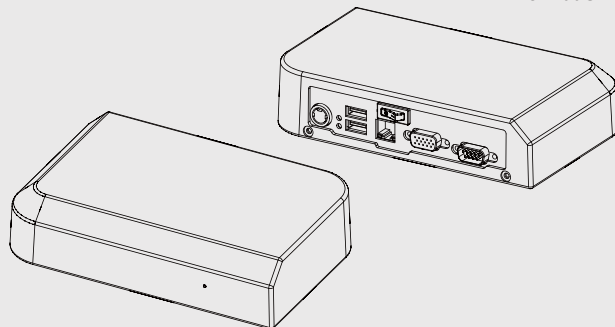
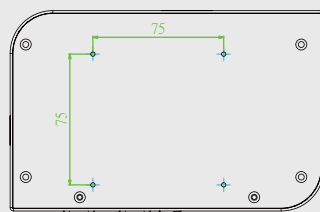

HS Italia
 Tel. 0536 830620
 Fax. 0536 831215
www.hs-italia.it
info@hs-italia.it

