

# LA-16/17/37/18/19/16G/17G/37G/18G LCD Monitor Wall Mount Kit

Handy and Convenient supporter



## LA-16

- Firmly fix on solid wall.
- For VESA mounting 75X75mm.
- Loading from 1~6kgs(2.2~13.2 lbs) LCD monitor.
- Two knuckles for adjusting:
  1. Swivel left & right total 180°.
  2. LCD Monitor swivel 270°.

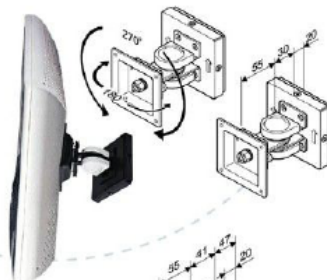

## LA-17

- Firmly fix on solid wall.
- For VESA mounting 75X75mm.
- Loading from 1~8kgs(2.2~17.6 lbs) LCD monitor.
- Three knuckles for adjusting:
  1. Swivel left & right total 180°.
  2. Pivot upwards & downwards.
  3. LCD Monitor swivel 270°.

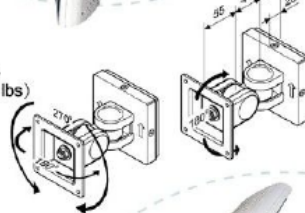

## LA-18

- Firmly fix on solid wall.
- For VESA mounting 75X75mm.
- Loading from 1~6kgs(2.2~13.2 lbs) LCD monitor.
- Four knuckles for adjusting:
  1. First & 2. Second knuckles swivel left & right total 180°.
  3. Pivot upwards & downwards.
  4. LCD Monitor swivel 270°.



## LA-37

- Firmly fix on solid wall.
- For VESA mounting 75X75mm, 100X100mm
- Loading from 7~14kgs(15.4~30.8 lbs) LCD monitor.
- Three knuckles for adjusting:
  1. Swivel left & right total 180°.
  2. Pivot upwards & downwards.
  3. LCD Monitor swivel 270°.



## Cute Wall Mount Kit

### LA-19

- Firmly mounts to solid wall.
- Meets VESA mounting position: 75X75mm.
- Loading capacity: 1~6kgs(2.2~13.2 lbs).
- Swivels to right and left up to 180°.
- Constructed of hard wear plastic.
- Pivots upwards to 10° and downwards to 25°.

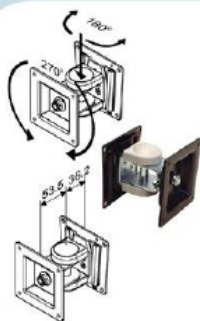
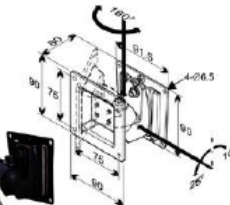

**LA-16G**

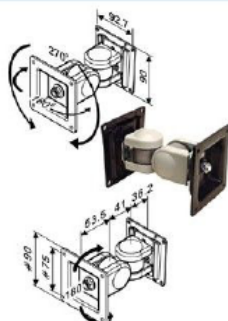

**LA-17G**

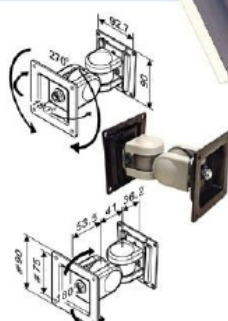

**LA-37G**

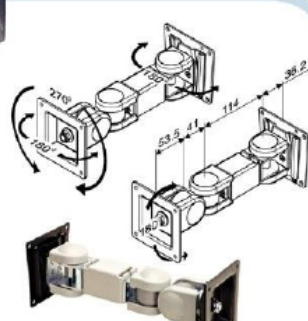

**LA-18G**